

LINEAR INTEGRATED CIRCUITS

POSITIVE VOLTAGE REGULATORS

- OUTPUT CURRENT UP TO 1.5A
- OUTPUT VOLTAGES OF 5; 6; 8; 12; 15; 18; 20; 24V
- THERMAL OVERLOAD PROTECTION
- SHORT CIRCUIT PROTECTION
- OUTPUT TRANSISTOR SOA PROTECTION

The L7800 series of three-terminal positive regulators is available in TO-220 and TO-3 packages and with several fixed output voltages, making it useful in a wide range of applications. These regulators can provide local on-card regulation, eliminating the distribution problems associated with single point regulation. Each type employs internal current limiting, thermal shut-down and safe area protection, making it essentially indestructible. If adequate heat sinking is provided, they can deliver over 1A output current. Although designed primarily as fixed voltage regulators, these devices can be used with external components to obtain adjustable voltages and currents.

ABSOLUTE MAXIMUM RATINGS

V_i	DC input voltage (for $V_o = 5$ to 18V) (for $V_o = 20, 24V$)	35 V 40 V
I_o	Output current	internally limited
P_{tot}	Power dissipation	internally limited
T_{op}	Operating junction temperature (for L7800) (for L7800C)	-55 to +150 °C 0 to +150 °C
T_{stg}	Storage temperature	-65 to +150 °C

MECHANICAL DATA

Dimensions in mm

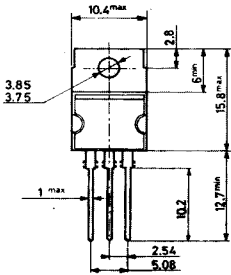
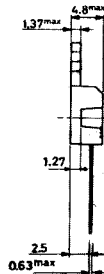
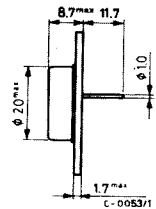
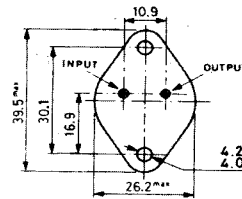

FIG. 10



TO-220



TO-3

L7800 Series

CONNECTION DIAGRAMS AND ORDERING NUMBERS

(top views)

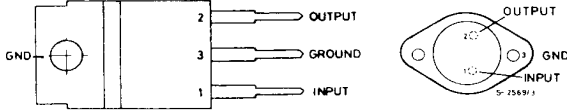

S-2568/1

Type	TO-220	TO-3	Output voltage
+5V L 7805 033058	—	L 7805T	5V
L 7805C	L 7805CV	L 7805 CT	5V
+6V L 7806 033535	—	L 7806T	6V
L 7806C	L 7806 CV	L 7806CT	6V
L 7808 033543	—	L 7808T	8V
+8V L 7808C	L 7808 CV	L 7808CT	8V
L 7812 033039	—	L 7812T	12V
+12V L 7812C	L 7812CV	L 7812CT	12V
L 7815 033244	—	L 7815T	15V
+15V L 7815C	L 7815CV	L 7815CT	15V
L 7818 010217	—	L 7818T	18V
+18V L 7818C	L 7818CV	L 7818CT	18V
L 7820 991114	—	L 7820T	20V
L 7820C	L 7820CV	L 7820CT	20V
+24V L 7824 032251	—	L 7824T	24V
L 7824C	L 7824CV	L 7824CT	24V

BLOCK DIAGRAM

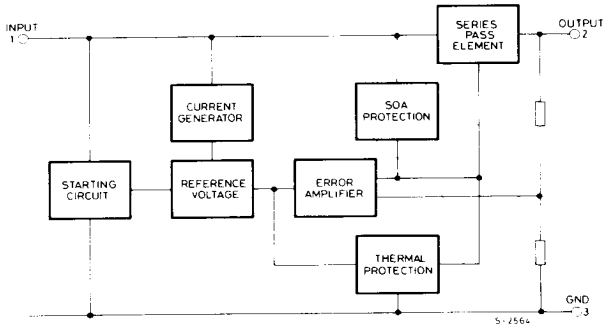

S-2564

SCHEMATIC DIAGRAM

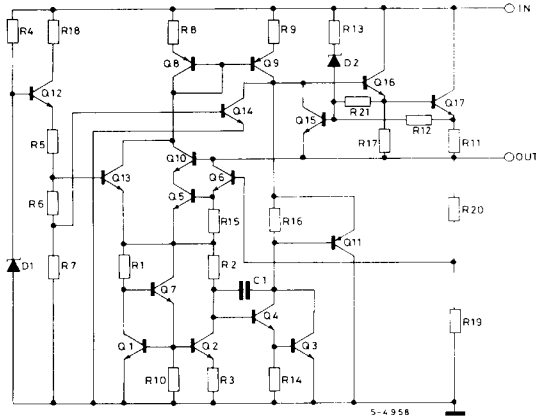

TEST CIRCUITS

Fig. 1 - DC parameters

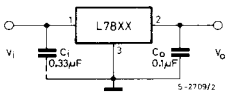

Fig. 2 - Load regulation

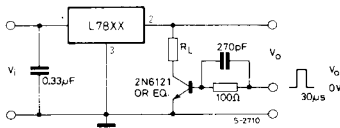
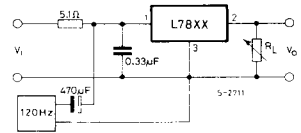

Fig. 3 - Ripple rejection



THERMAL DATA

			TO-220	TO-3
$R_{th\ j-case}$	Thermal resistance junction-case	max	3 °C/W	4 °C/W
$R_{th\ j-amb}$	Thermal resistance junction-ambient	max	50 °C/W	35 °C/W

L7800 Series

ELECTRICAL CHARACTERISTICS L 7800 (Refer to the test circuits, $T_j = -55$ to 150°C , $I_o = 500$ mA, $C_i = 0.33$ μF , $C_o = 0.1$ μF unless otherwise specified)

OUTPUT VOLTAGE		5			6			8			12			Unit			
INPUT VOLTAGE (Unless otherwise specified)		10			11			14			19						
Parameter	Test conditions	Min.	Typ.	Max.	Min.	Typ.	Max.	Min.	Typ.	Max.	Min.	Typ.	Max.				
V_o	Output voltage	$T_j = 25^\circ\text{C}$			4.8	5	5.2	5.75	6	6.25	7.7	8	8.3	11.5	12	12.5	V
		$I_o = 5$ mA to 1A $P_o \leq 15\text{W}$	4.65	5	5.35 ($V_i = 8$ to 20V)	5.65	6	6.35 ($V_i = 9$ to 21V)	7.6	8	8.4 ($V_i = 11.5$ to 23V)	11.4	12	12.6 ($V_i = 15.5$ to 27V)			
ΔV_o	Line regulation	$T_j = 25^\circ\text{C}$	50 ($V_i = 7$ to 25V)			60 ($V_i = 8$ to 25V)			80 ($V_i = 10.5$ to 25V)			120 ($V_i = 14.5$ to 30V)			mV		
			25 ($V_i = 8$ to 12V)			30 ($V_i = 9$ to 13V)			40 ($V_i = 11$ to 17V)			60 ($V_i = 16$ to 22V)					
ΔV_o	Load regulation	$T_j = 25^\circ\text{C}$ $I_o = 5$ mA to 1.5A	100			100			100			120			mV		
		$T_j = 25^\circ\text{C}$ $I_o = 250$ to 750 mA	25			30			40			60					
I_d	Quiescent current	$T_j = 25^\circ\text{C}$			6			6			6			6	mA		
ΔI_d	Quiescent current change	$I_o = 5$ mA to 1A		0.5			0.5			0.5			0.5			mA	
				0.8 ($V_i = 8$ to 25V)			0.8 ($V_i = 9$ to 25V)			0.8 ($V_i = 11.5$ to 25V)			0.8 ($V_i = 15$ to 30V)				
$\frac{\Delta V_o}{\Delta T}$	Output voltage drift	$I_o = 5$ mA		0.6			0.7			1			1.5			mV/ $^\circ\text{C}$	
e_N	output noise voltage	B = 10Hz to 100KHz $T_j = 25^\circ\text{C}$		40			40			40			40			$\frac{\mu\text{V}}{V_o}$	
SVR	Supply voltage rejection	f = 120 Hz		68 ($V_i = 8$ to 18V)			65 ($V_i = 9$ to 19V)			62 ($V_i = 11.5$ to 21.5V)			61 ($V_i = 15$ to 25V)			dB	
V_d	Dropout voltage	$I_o = 1$ A $T_j = 25^\circ\text{C}$		2			2			2			2			V	
R_o	Output resistance	f = 1 KHz		17			19			16			18			m Ω	
I_{sc}	Short circuit current	$V_i = 35\text{V}$ $T_j = 25^\circ\text{C}$		0.75			0.75			0.75			0.75			A	
I_{scp}	Short circ. peak current	$T_j = 25^\circ\text{C}$		1.3			1.3			1.3			1.3			A	

ELECTRICAL CHARACTERISTICS L 7800 (continued)

OUTPUT VOLTAGE		15			18			20			24			Unit									
INPUT VOLTAGE (Unless otherwise specified)		23			26			28			33												
Parameter	Test conditions	Min.	Typ.	Max.	Min.	Typ.	Max.	Min.	Typ.	Max.	Min.	Typ.	Max.										
V _O	Output voltage	T _J = 25°C			14.4	15	15.6	17.3	18	18.7	19.2	20	20.8	23	24	25	V						
		I _O = 5 mA to 1 A P _O ≤ 15W			14.25	15	15.75	17.1	18	18.9	19	20	21	22.8	24	25.2							
ΔV _O	Line regulation	T _J = 25°C			150 (V _I = 17.5 to 30V)			180 (V _I = 21 to 33V)			200 (V _I = 22.5 to 35V)			240 (V _I = 27 to 38V)			mV						
					75 (V _I = 20 to 26V)			90 (V _I = 24 to 30V)			100 (V _I = 26 to 32V)			120 (V _I = 30 to 36V)									
ΔV _O	Load regulation	T _J = 25°C I _O = 5 mA to 1.5A			150			180			200			240			mV						
		T _J = 25°C I _O = 250 to 750 mA			75			90			100			120									
I _d	Quiescent current	T _J = 25°C			6			6			6			6			mA						
ΔI _d	Quiescent current change	I _O = 5 mA to 1 A			0.5			0.5			0.5			0.5			mA						
					0.8 (V _I = 18.5 to 30V)			0.8 (V _I = 22 to 33V)			0.8 (V _I = 24 to 35V)			0.8 (V _I = 28 to 38V)									
$\frac{\Delta V_O}{\Delta T}$	Output voltage drift	I _O = 5 mA			1.8			2.3			2.5			3			mV/°C						
e _N	output noise voltage	B = 10Hz to 100KHz T _J = 25°C			40			40			40			40			$\frac{\mu V}{V_O}$						
SVR	Supply voltage rejection	f = 120 Hz			60 (V _I = 18.5 to 28.5V)			59 (V _I = 22 to 32V)			58 (V _I = 24 to 35V)			56 (V _I = 28 to 38V)			dB						
V _d	Dropout voltage	I _O = 1 A T _J = 25°C			2			2.5			2			2.5			V						
R _O	Output resistance	f = 1 KHz			19			22			24			28			mΩ						
I _{sc}	Short circuit current	V _I = 35V T _J = 25°C			0.75			1.2			0.75			1.2			A						
I _{scp}	Short circ. peak current	T _J = 25°C			1.3			2.2			3.3			1.3			2.2			3.3			A

L7800 Series

ELECTRICAL CHARACTERISTICS L 7800C (Refer to the test circuits, $T_j = 0$ to 125°C , $I_o = 500$ mA, $C_i = 0.33$ μF , $C_o = 0.1$ μF unless otherwise specified)

OUTPUT VOLTAGE		5			6			8			12			Unit			
INPUT VOLTAGE (Unless otherwise specified)		10			11			14			19						
Parameter	Test conditions	Min.	Typ.	Max.	Min.	Typ.	Max.	Min.	Typ.	Max.	Min.	Typ.	Max.				
V_o	Output voltage	$T_j = 25^\circ\text{C}$			4.8	5	5.2	5.75	6	6.25	7.7	8	8.3	11.5	12	12.5	V
		$I_o = 5$ mA to 1 A $P_o \leq 15$ W			4.75	5	5.25 ($V_i = 7$ to 20V)	5.7	6	6.3 ($V_i = 8$ to 21V)	7.6	8	8.4 ($V_i = 10.5$ to 25V)	11.4	12	12.6 ($V_i = 14.5$ to 27V)	
ΔV_o	Line regulation	$T_j = 25^\circ\text{C}$			3 100 ($V_i = 7$ to 25V)			120 ($V_i = 8$ to 25V)			160 ($V_i = 10.5$ to 25V)			240 ($V_i = 14.5$ to 30V)			mV
					1 50 ($V_i = 8$ to 12V)			60 ($V_i = 9$ to 13V)			80 ($V_i = 11$ to 17V)			120 ($V_i = 16$ to 22V)			
ΔV_o	Load regulation	$T_j = 25^\circ\text{C}$ $I_o = 5$ mA to 1.5A			100			120			160			240			mV
		$T_j = 25^\circ\text{C}$ $I_o = 250$ to 750 mA			50			60			80			120			
I_d	Quiescent current	$T_j = 25^\circ\text{C}$			8			8			8			8			mA
ΔI_d	Quiescent current change	$I_o = 5$ mA to 1 A			0.5			0.5			0.5			0.5			mA
					1.3 ($V_i = 7$ to 25V)			1.3 ($V_i = 8$ to 25V)			1 ($V_i = 10.5$ to 25V)			1 ($V_i = 14.5$ to 30V)			
$\frac{\Delta V_o}{\Delta T}$	Output voltage drift	$I_o = 5$ mA			-1.1			-0.8			-0.8			-1			mV/ $^\circ\text{C}$
e_N	Output noise voltage	B= 10Hz to 100KHz $T_j = 25^\circ\text{C}$			40			45			52			75			μV
SVR	Supply voltage rejection	f = 120 Hz			62 ($V_i = 8$ to 18V)			59 ($V_i = 9$ to 19V)			56 ($V_i = 11.5$ to 21.5V)			55 ($V_i = 15$ to 25V)			dB
V_d	Dropout voltage	$I_o = 1$ A			2			2			2			2			V
R_o	Output resistance	f = 1 KHz			17			19			16			18			m Ω
I_{sc}	Short circuit current	$V_i = 35$ V $T_j = 25^\circ\text{C}$			750			550			450			350			mA
I_{scp}	Short circ. peak current	$T_j = 25^\circ\text{C}$			2.2			2.2			2.2			2.2			A

ELECTRICAL CHARACTERISTICS L 7800C (continued)

OUTPUT VOLTAGE		15			18			20			24			Unit
INPUT VOLTAGE (Unless otherwise specified)		23			26			28			33			
Parameter	Test conditions	Min.	Typ.	Max.	Min.	Typ.	Max.	Min.	Typ.	Max.	Min.	Typ.	Max.	
V _o Output voltage	T _j = 25°C	14.4	15	15.6	17.3	18	18.7	19.2	20	20.8	23	24	25	V
	I _o = 5 mA to 1A P _o ≤ 15W	14.25 (V _i = 17.5 to 30V)	15	15.75	17.1 (V _i = 21 to 33V)	18	18.9	19 (V _i = 23 to 35V)	20	21	22.8 (V _i = 27 to 38V)	24	25.2	
ΔV _o Line regulation	T _j = 25°C	300 (V _i = 17.5 to 30V)			360 (V _i = 21 to 33V)			400 (V _i = 22.5 to 35V)			480 (V _i = 27 to 38V)			mV
		150 (V _i = 20 to 26V)			180 (V _i = 24 to 30V)			200 (V _i = 26 to 32V)			240 (V _i = 30 to 36V)			
ΔV _o Load regulation	T _j = 25°C I _o = 5 mA to 1.5A	300			360			400			480			mV
		150			180			200			240			
I _d Quiescent current	T _j = 25°C	8			8			8			8			mA
ΔI _d Quiescent current change	I _o = 5 mA to 1A	0.5			0.5			0.5			0.5			mA
		1 (V _i = 17.5 to 30V)			1 (V _i = 21 to 33V)			1 (V _i = 23 to 35V)			1 (V _i = 27 to 38V)			
$\frac{\Delta V_o}{\Delta T}$ Output voltage drift	I _o = 5 mA	-1			-1			-1			-1.5			mV/°C
e _N Output noise voltage	B = 10Hz to 100KHz T _j = 25°C	90			110			150			170			μV
SVR Supply voltage rejection	f = 120 Hz	54			53			52			50			dB
V _d Dropout voltage	I _o = 1A	2			2			2			2			V
R _o Output resistance	f = 1 KHz	19			22			24			28			mΩ
I _{sc} Short circuit current	V _i = 35V T _j = 25°C	230			200			180			150			mA
I _{scp} Short circ. peak current	T _j = 25°C	2.1			2.1			2.1			2.1			A

L7800 Series

Fig. 4 - Dropout voltage vs. junction temperature

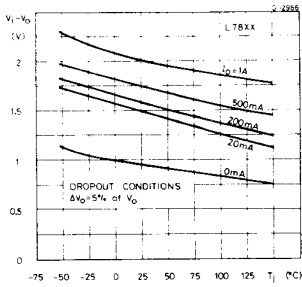

Fig. 5 - Peak output current vs. input/output differential voltage

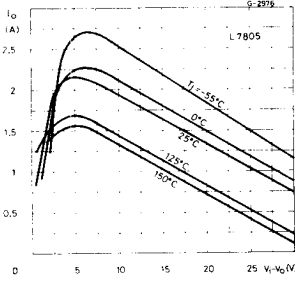

Fig. 6 - Supply voltage rejection vs. frequency

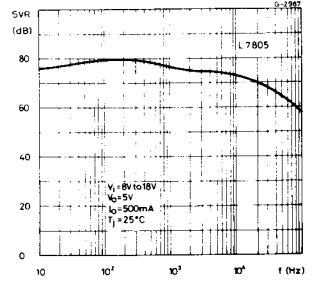

Fig. 7 - Output voltage vs. junction temperature

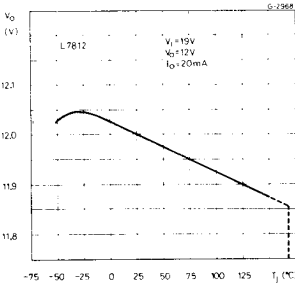

Fig. 8 - Output impedance vs. frequency

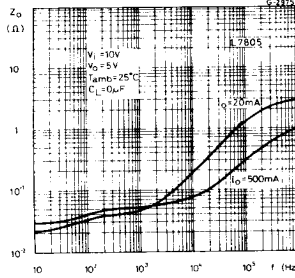

Fig. 9 - Quiescent current vs. junction temperature

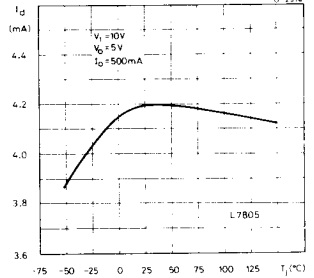

Fig. 10 - Load transient response

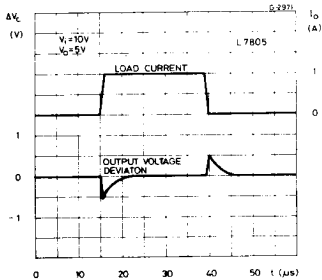

Fig. 11 - Line transient response

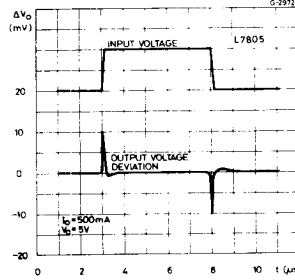
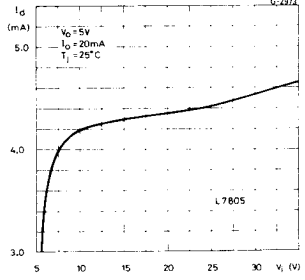
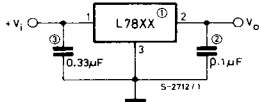

Fig. 12 - Quiescent current vs. input voltage



APPLICATION INFORMATION (continued)

Fig. 13 - Fixed output regulator



- Notes:**
- (1) To specify an output voltage, substitute voltage value for "XX".
 - (2) Although no output capacitor is needed for stability, it does improve transient response.
 - (3) Required if regulator is located an appreciable distance from power supply filter.

Fig. 14 - Current regulator

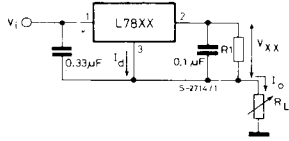

$$I_o = \frac{V_{XX}}{R_1} + I_d$$

Fig. 15 - Circuit for increasing output voltage

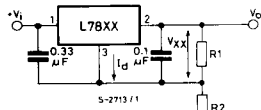

$$I_{R1} \geq 5 I_d$$

$$V_o = V_{XX} \left(1 + \frac{R_2}{R_1} \right) + I_d R_2$$

Fig. 16 - Adjustable output regulator (7 to 30V)

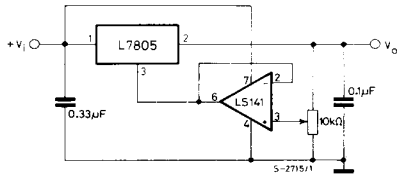
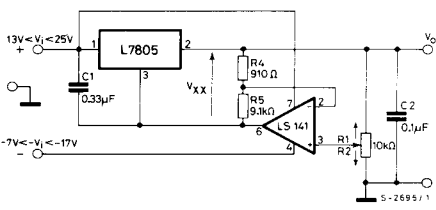
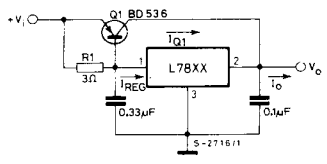

Fig. 17 - 0.5 to 10V regulator



$$V_o = V_{XX} \frac{R_4}{R_1}$$

Fig. 18 - High current voltage regulator



$$R_1 = \frac{V_{BEQ1}}{I_{REG} - \frac{I_{Q1}}{\beta_{Q1}}}$$

$$I_o = I_{REG} + \beta_{Q1} \left[I_{REG} - \frac{V_{BEQ1}}{R_1} \right]$$

APPLICATION INFORMATION (continued)

Fig. 19 - High output current with short circuit protection

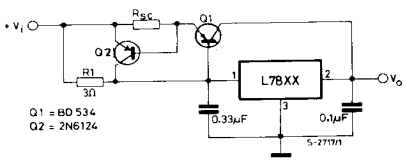

$$R_{SC} = \frac{V_{BEQ2}}{I_{SC}}$$

Fig. 20 - Tracking voltage regulator

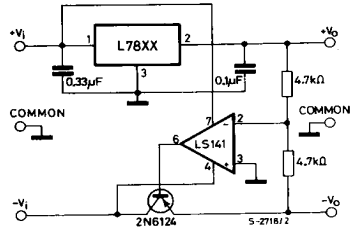
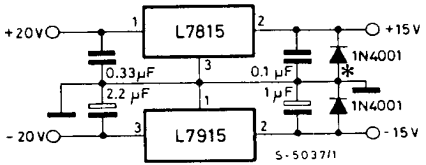

Fig. 21 - Split power supply (±15V - 1A)



* Against potential latch-up problems

Fig. 22 - Negative output voltage circuit

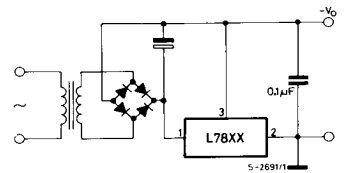

Fig. 23 - Switching regulator

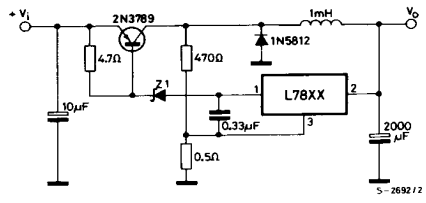
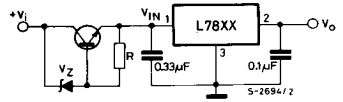

Fig. 24 - High input voltage circuit



$$V_{IN} = V_I - (V_Z + V_{BE})$$

APPLICATION INFORMATION (continued)

Fig. 25 - High input voltage circuit

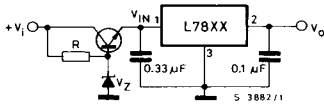

$$V_{IN} = V_Z - V_{BE}$$

Fig. 26 - High output voltage regulator

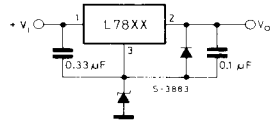
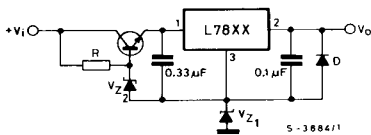
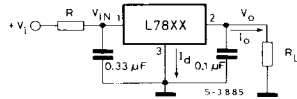

Fig. 27 - High input and output voltage



$$V_O = V_{XX} + V_{Z1}$$

Fig. 28 - Reducing power dissipation with dropping resistor



$$R = \frac{V_{i(\min)} - V_{XX} - V_{DROP(\max)}}{I_o(\max) + I_d(\max)}$$

Fig. 29 - Remote shutdown

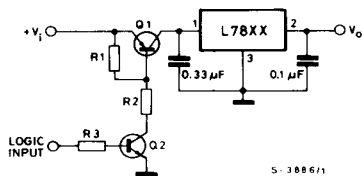

APPLICATION INFORMATION (continued)

Fig. 30 - Power AM modulator (unity voltage gain, $I_o \leq 1A$)

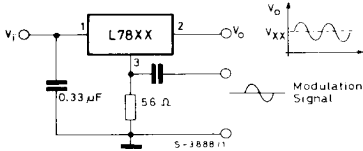

Note: The circuit performs well up to 100 KHz.

Fig. 31 - Adjustable output voltage with temperature compensation

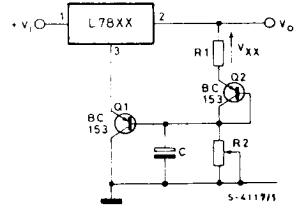

Note: Q₂ is connected as a diode in order to compensate the variation of the Q₁ V_{BE} with the temperature. C allows a slow rise-time of the V_o

$$V_o = V_{XX} \left(1 + \frac{R_2}{R_1} \right) + V_{BE}$$

Fig. 32 - Light controllers ($V_o \min = V_{XX} + V_{BE}$)

(a)

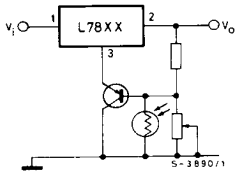

V_o falls when the light goes up

(b)

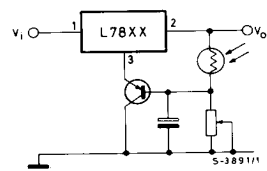

V_o rises when the light goes up

Fig. 33 - Protection against input short-circuit with high capacitance loads

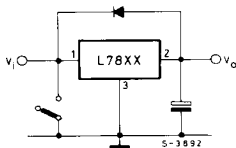

Applications with high capacitance loads and an output voltage greater than 6 volts need an external diode (see fig. 33) to protect the device against input short circuit. In this case the input voltage falls rapidly while the output voltage decreases slowly. The capacitance discharges by means of the Base-Emitter junction of the series pass transistor in the regulator. If the energy is sufficiently high, the transistor may be destroyed. The external diode by-passes the current from the IC to ground.