

Features

- High short circuit rating optimized for motor control, $t_{sc} = 10\mu s$, $V_{CC} = 720V$, $T_J = 125^\circ C$, $V_{GE} = 15V$
- Combines low conduction losses with high switching speed
- Latest generation design provides tighter parameter distribution and higher efficiency than previous generations

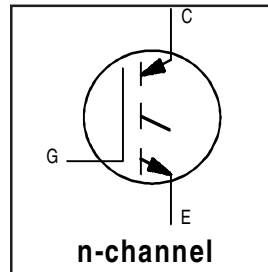

$V_{CES} = 1200V$
$V_{CE(on)} \text{ typ.} = 2.74V$
@ $V_{GE} = 15V, I_C = 15A$

Benefits

- As a Freewheeling Diode we recommend our HEXFRED™ ultrafast, ultrasoft recovery diodes for minimum EMI / Noise and switching losses in the Diode and IGBT
- Latest generation 4 IGBT's offer highest power density motor controls possible
- This part replaces the IRGPH40K and IRGPH40M devices

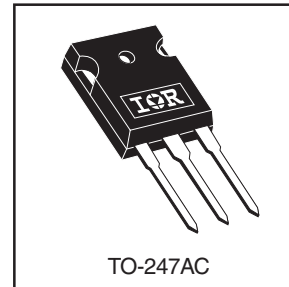

Absolute Maximum Ratings

	Parameter	Max.	Units
V_{CES}	Collector-to-Emitter Voltage	1200	V
$I_C @ T_C = 25^\circ C$	Continuous Collector Current	30	A
$I_C @ T_C = 100^\circ C$	Continuous Collector Current	15	
I_{CM}	Pulsed Collector Current ①	60	
I_{LM}	Clamped Inductive Load Current ②	60	
t_{sc}	Short Circuit Withstand Time	10	μs
V_{GE}	Gate-to-Emitter Voltage	± 20	V
E_{ARV}	Reverse Voltage Avalanche Energy ③	180	mJ
$P_D @ T_C = 25^\circ C$	Maximum Power Dissipation	160	W
$P_D @ T_C = 100^\circ C$	Maximum Power Dissipation	65	
T_J	Operating Junction and Storage Temperature Range	-55 to +150	$^\circ C$
	Soldering Temperature, for 10 sec.	300 (0.063 in. (1.6mm) from case)	
	Mounting torque, 6-32 or M3 screw.	10 lbf•in (1.1N•m)	

Thermal Resistance

	Parameter	Typ.	Max.	Units
$R_{\theta JC}$	Junction-to-Case	—	0.77	$^\circ C/W$
$R_{\theta CS}$	Case-to-Sink, Flat, Greased Surface	0.24	—	
$R_{\theta JA}$	Junction-to-Ambient, typical socket mount	—	40	
Wt	Weight	6 (0.21)	—	g (oz)

Electrical Characteristics @ $T_J = 25^\circ\text{C}$ (unless otherwise specified)

	Parameter	Min.	Typ.	Max.	Units	Conditions
$V_{(BR)CES}$	Collector-to-Emitter Breakdown Voltage	1200	—	—	V	$V_{GE} = 0\text{V}$, $I_C = 250\mu\text{A}$
$V_{(BR)ECS}$	Emitter-to-Collector Breakdown Voltage ④	18	—	—	V	$V_{GE} = 0\text{V}$, $I_C = 1.0\text{A}$
$\Delta V_{(BR)CES}/\Delta T_J$	Temperature Coeff. of Breakdown Voltage	—	0.37	—	V/°C	$V_{GE} = 0\text{V}$, $I_C = 1.0\text{mA}$
$V_{CE(ON)}$	Collector-to-Emitter Saturation Voltage	—	2.54	—	V	$V_{GE} = 15\text{V}$ See Fig.2, 5
		—	2.74	3.4		
		—	3.29	—		
		—	2.53	—		
$V_{GE(th)}$	Gate Threshold Voltage	3.0	—	6.0		$I_C = 10\text{A}$ $I_C = 15\text{A}$ $I_C = 30\text{A}$ $I_C = 15\text{A}$, $T_J = 150^\circ\text{C}$
$\Delta V_{GE(th)}/\Delta T_J$	Temperature Coeff. of Threshold Voltage	—	-3.3	—	mV/°C	$V_{CE} = V_{GE}$, $I_C = 250\mu\text{A}$
g_{fe}	Forward Transconductance ⑤	8.0	12	—	S	$V_{CE} = 100\text{V}$, $I_C = 15\text{A}$
I_{CES}	Zero Gate Voltage Collector Current	—	—	250	μA	$V_{GE} = 0\text{V}$, $V_{CE} = 1200\text{V}$
		—	—	2.0		$V_{GE} = 0\text{V}$, $V_{CE} = 10\text{V}$, $T_J = 25^\circ\text{C}$
		—	—	3000		$V_{GE} = 0\text{V}$, $V_{CE} = 1200\text{V}$, $T_J = 150^\circ\text{C}$
I_{GES}	Gate-to-Emitter Leakage Current	—	—	± 100	nA	$V_{GE} = \pm 20\text{V}$

Switching Characteristics @ $T_J = 25^\circ\text{C}$ (unless otherwise specified)

	Parameter	Min.	Typ.	Max.	Units	Conditions
Q_g	Total Gate Charge (turn-on)	—	94	140	nC	$I_C = 15\text{A}$ $V_{CC} = 400\text{V}$ $V_{GE} = 15\text{V}$ See Fig.8
Q_{ge}	Gate - Emitter Charge (turn-on)	—	14	22		
Q_{gc}	Gate - Collector Charge (turn-on)	—	37	55		
$t_{d(on)}$	Turn-On Delay Time	—	30	—	ns	$T_J = 25^\circ\text{C}$ $I_C = 15\text{A}$, $V_{CC} = 960\text{V}$ $V_{GE} = 15\text{V}$, $R_G = 10\Omega$ Energy losses include "tail"
t_r	Rise Time	—	22	—		
$t_{d(off)}$	Turn-Off Delay Time	—	200	300		
t_f	Fall Time	—	150	230		
E_{on}	Turn-On Switching Loss	—	0.73	—	mJ	See Fig. 9,10,14
E_{off}	Turn-Off Switching Loss	—	1.66	—		
E_{ts}	Total Switching Loss	—	2.39	2.9		
t_{sc}	Short Circuit Withstand Time	10	—	—	μs	$V_{CC} = 720\text{V}$, $T_J = 125^\circ\text{C}$ $V_{GE} = 15\text{V}$, $R_G = 10\Omega$
$t_{d(on)}$	Turn-On Delay Time	—	29	—	ns	$T_J = 150^\circ\text{C}$, $I_C = 15\text{A}$, $V_{CC} = 960\text{V}$ $V_{GE} = 15\text{V}$, $R_G = 10\Omega$ Energy losses include "tail"
t_r	Rise Time	—	24	—		
$t_{d(off)}$	Turn-Off Delay Time	—	870	—		
t_f	Fall Time	—	330	—		
E_{ts}	Total Switching Loss	—	4.93	—	mJ	See Fig. 10,11,14
E_{on}	Turn-On Switching Loss	—	0.37	—	mJ	$T_J = 25^\circ\text{C}$, $V_{GE} = 15\text{V}$, $R_G = 10\Omega$ $I_C = 10\text{A}$, $V_{CC} = 960\text{V}$ Energy losses include "tail"
E_{off}	Turn-Off Switching Loss	—	0.89	—		
E_{ts}	Total Switching Loss	—	1.26	—		
L_E	Internal Emitter Inductance	—	13	—	nH	Measured 5mm from package
C_{ies}	Input Capacitance	—	1600	—	pF	$V_{GE} = 0\text{V}$ $V_{CC} = 30\text{V}$ $f = 1.0\text{MHz}$ See Fig. 7
C_{oes}	Output Capacitance	—	77	—		
C_{res}	Reverse Transfer Capacitance	—	26	—		

Details of note ① through ⑤ are on the last page

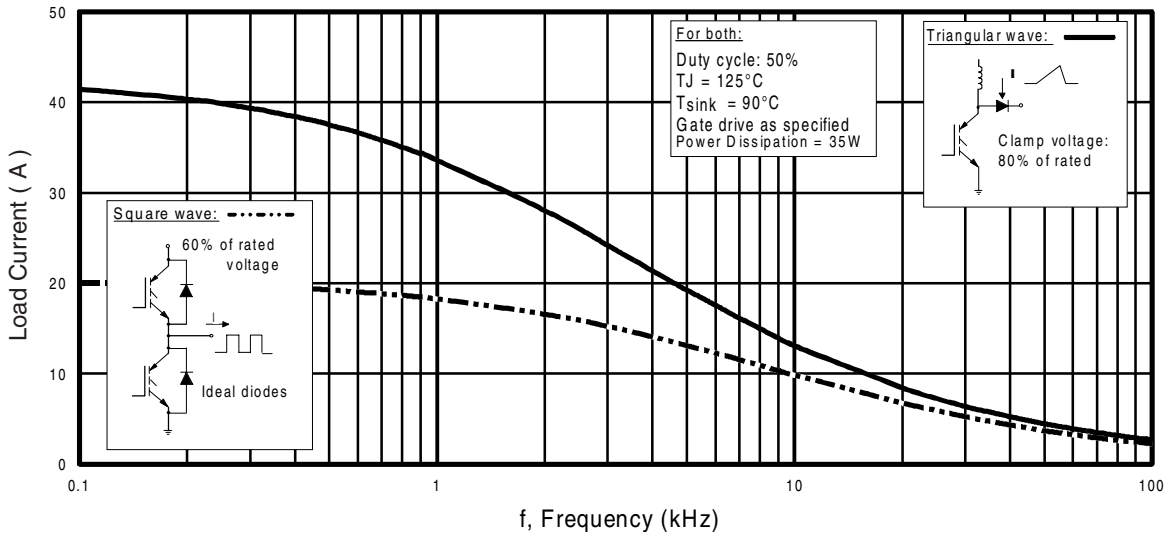

Fig. 1 - Typical Load Current vs. Frequency
(Load Current = I_{RMS} of fundamental)

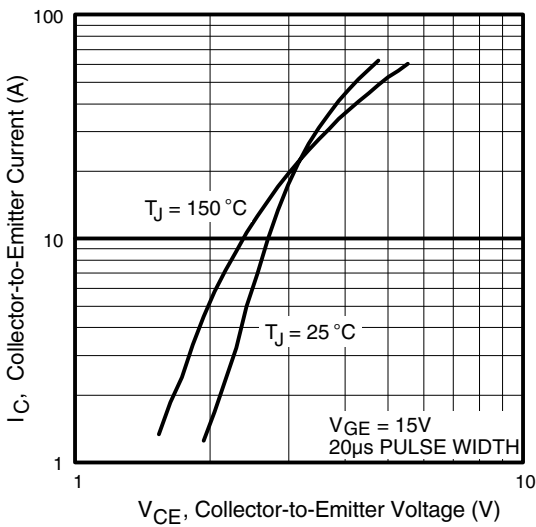

Fig. 2 - Typical Output Characteristics

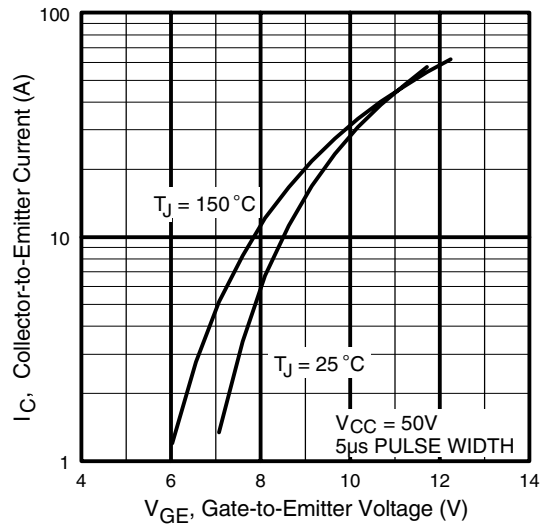

Fig. 3 - Typical Transfer Characteristics

IRG4PH40K

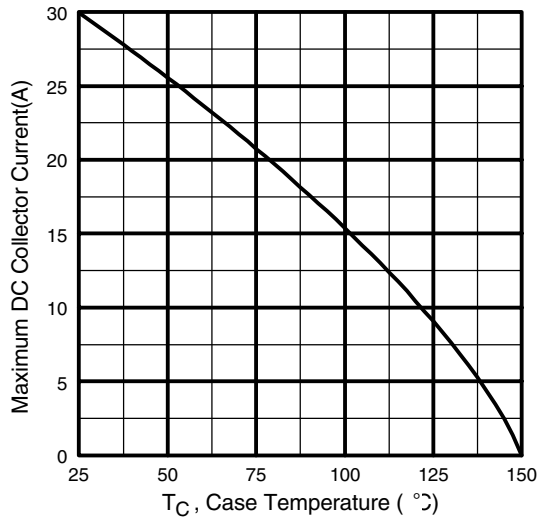

Fig. 4 - Maximum Collector Current vs. Case Temperature

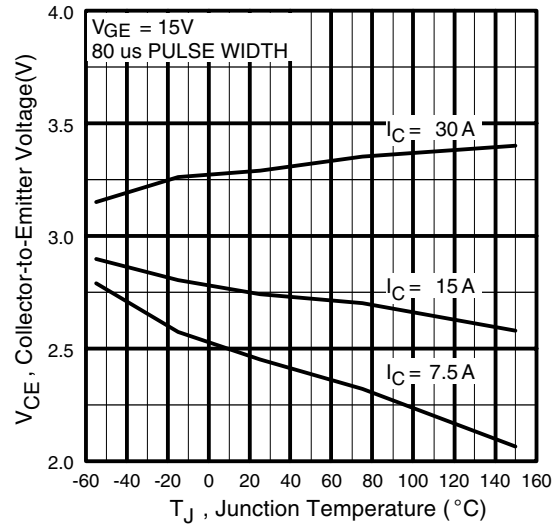

Fig. 5 - Typical Collector-to-Emitter Voltage vs. Junction Temperature

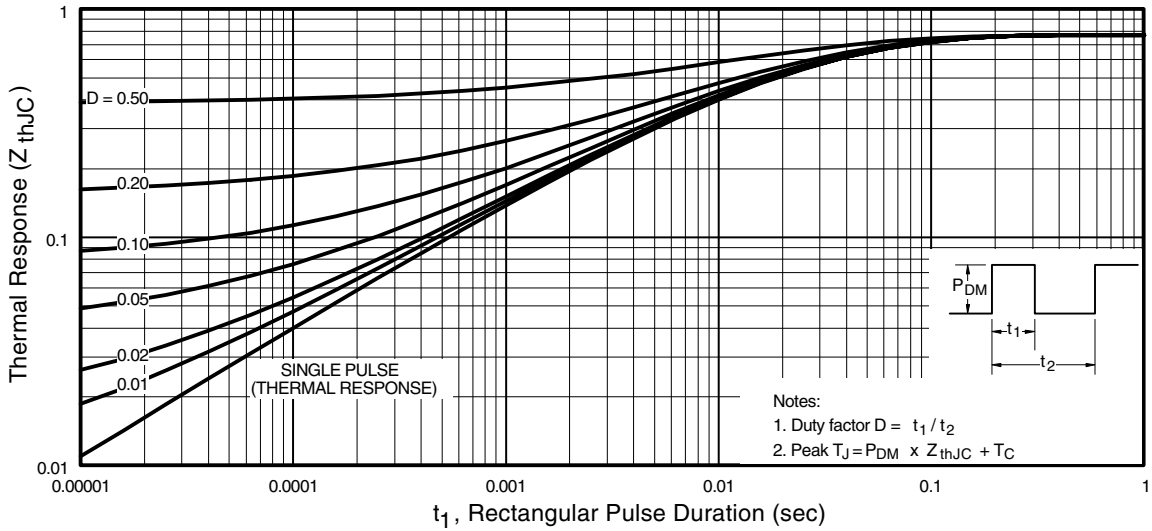

Fig. 6 - Maximum Effective Transient Thermal Impedance, Junction-to-Case

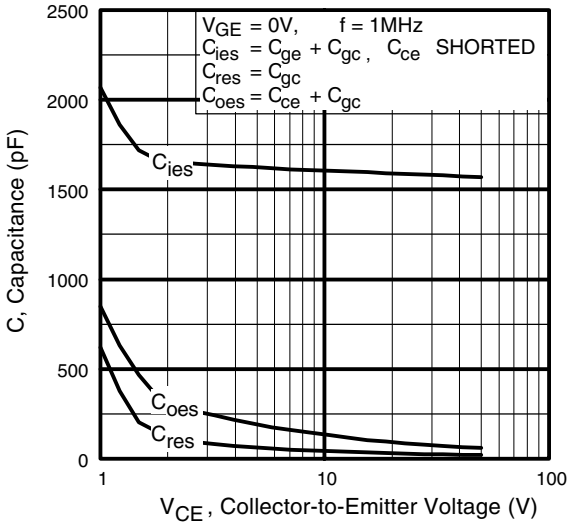

Fig. 7 - Typical Capacitance vs. Collector-to-Emitter Voltage

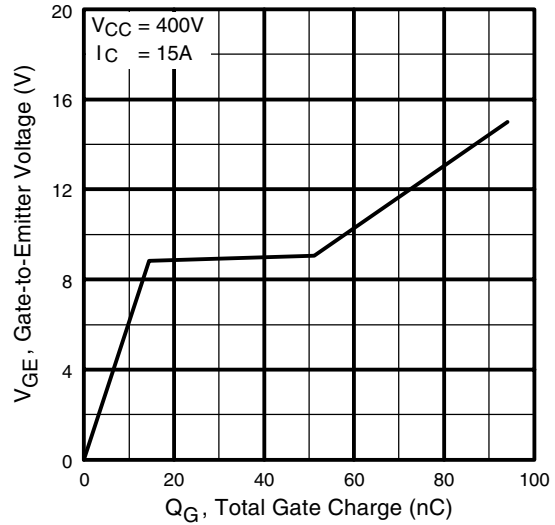

Fig. 8 - Typical Gate Charge vs. Gate-to-Emitter Voltage

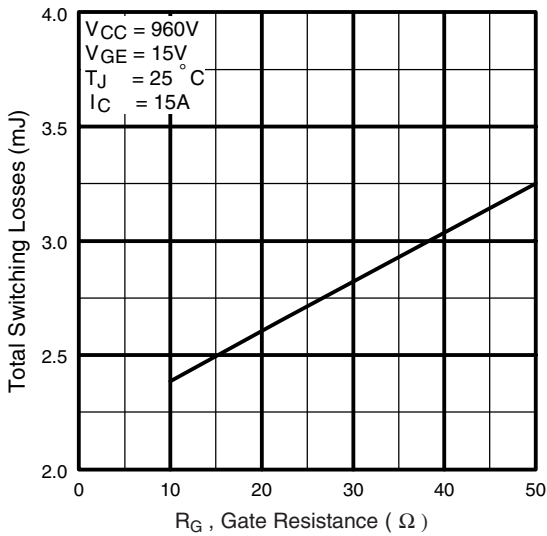

Fig. 9 - Typical Switching Losses vs. Gate Resistance

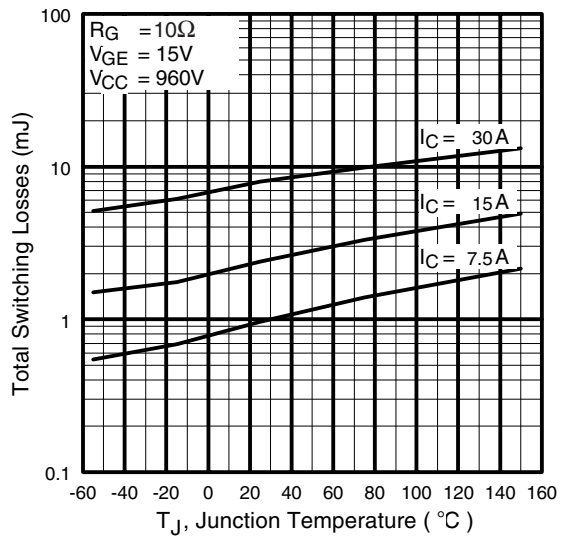

Fig. 10 - Typical Switching Losses vs. Junction Temperature

IRG4PH40K

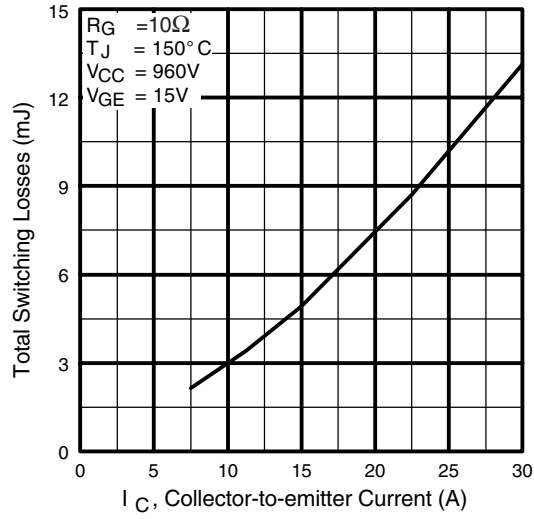

Fig. 11 - Typical Switching Losses vs. Collector-to-Emitter Current

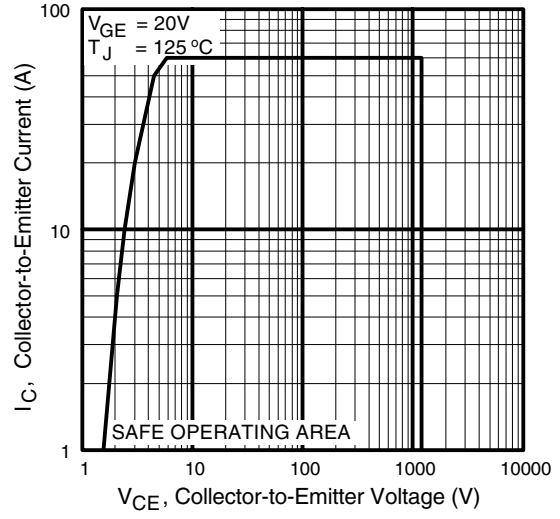

Fig. 12 - Turn-Off SOA

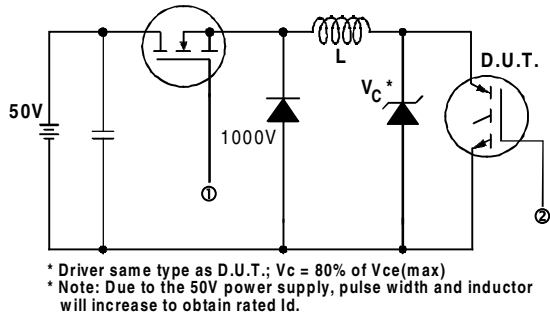

Fig. 13a - Clamped Inductive Load Test Circuit

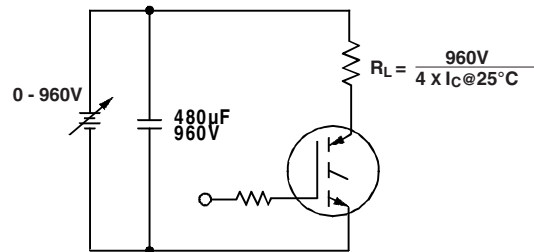

Fig. 13b - Pulsed Collector Current Test Circuit

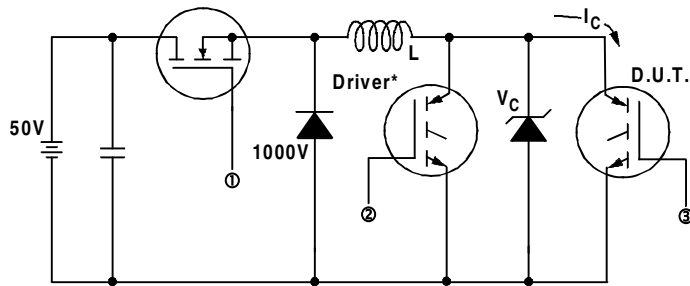

Fig. 14a - Switching Loss Test Circuit

* Driver same type as D.U.T., $V_C = 960V$

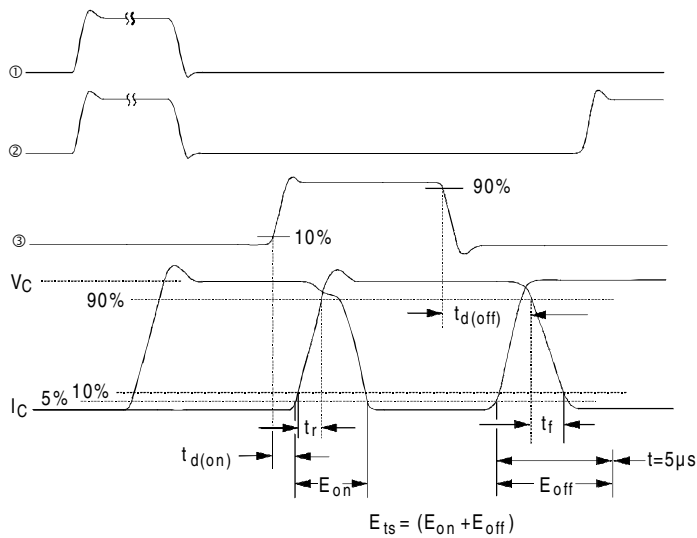

Fig. 14b - Switching Loss Waveforms

IRG4PH40K

International
IR Rectifier

Notes:

- ① Repetitive rating; $V_{GE} = 20V$, pulse width limited by max. junction temperature. (See fig. 13b)
- ② $V_{CC} = 80\%(V_{CES})$, $V_{GE} = 20V$, $L = 10\mu H$, $R_G = 10\Omega$, (See fig. 13a)
- ③ Repetitive rating; pulse width limited by maximum junction temperature.
- ④ Pulse width $\leq 80\mu s$; duty factor $\leq 0.1\%$.
- ⑤ Pulse width $5.0\mu s$, single shot.

Case Outline and Dimensions — TO-247AC

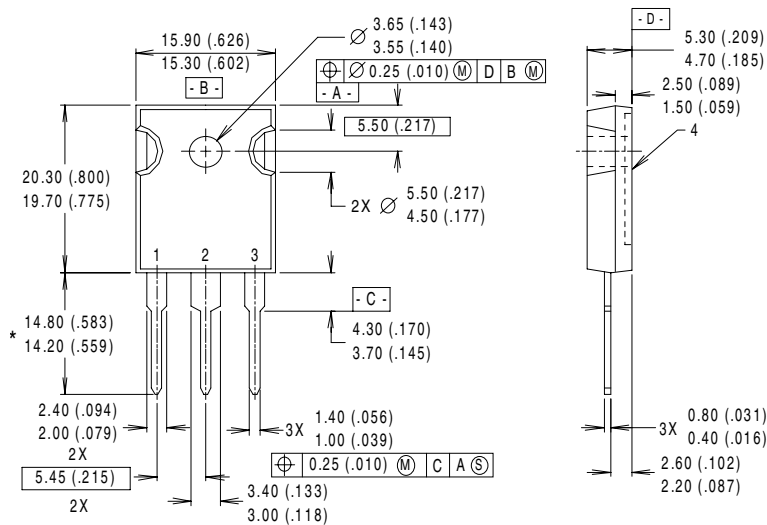

NOTES:

- 1 DIMENSIONS & TOLERANCING PER ANSI Y14.5M, 1982.
- 2 CONTROLLING DIMENSION : INCH.
- 3 DIMENSIONS ARE SHOWN MILLIMETERS (INCHES).
- 4 CONFORMS TO JEDEC OUTLINE TO-247AC.

LEAD ASSIGNMENTS

- 1 - GATE
- 2 - COLLECTOR
- 3 - EMITTER
- 4 - COLLECTOR

* LONGER LEADED (20mm)
VERSION AVAILABLE (TO-247AD)
TO ORDER ADD "E" SUFFIX
TO PART NUMBER

CONFORMS TO JEDEC OUTLINE TO-247AC (TO-3P)

Dimensions in Millimeters and (Inches)

International
IR Rectifier

IR WORLD HEADQUARTERS: 233 Kansas St., El Segundo, California 90245, USA Tel: (310) 252-7105
IR EUROPEAN REGIONAL CENTRE: 439/445 Godstone Rd, Whyteleafe, Surrey CR3 OBL, UK Tel: ++ 44 (0)20 8645 8000
IR CANADA: 15 Lincoln Court, Brampton, Ontario L6T3Z2, Tel: (905) 453 2200
IR GERMANY: Saalburgstrasse 157, 61350 Bad Homburg Tel: ++ 49 (0) 6172 96590
IR ITALY: Via Liguria 49, 10071 Borgaro, Torino Tel: ++ 39 011 451 0111
IR JAPAN: K&H Bldg., 2F, 30-4 Nishi-Ikebukuro 3-Chome, Toshima-Ku, Tokyo 171 Tel: 81 (0)3 3983 0086
IR SOUTHEAST ASIA: 1 Kim Seng Promenade, Great World City West Tower, 13-11, Singapore 237994 Tel: ++ 65 (0)838 4630
IR TAIWAN: 16 Fl. Suite D. 207, Sec. 2, Tun Haw South Road, Taipei, 10673 Tel: 886-(0)2 2377 9936
Data and specifications subject to change without notice. 6/00